

Modeller og tilbehør

MOLOK®

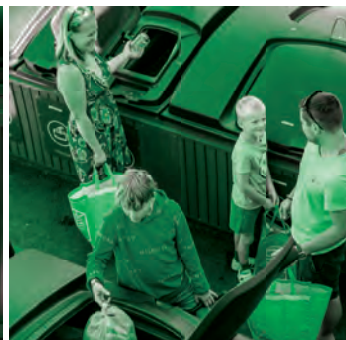

Molok® Classic
Molok® Domino

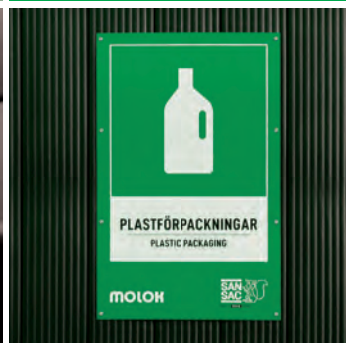

Molok® Domino Tilbehør

Molok® Domino

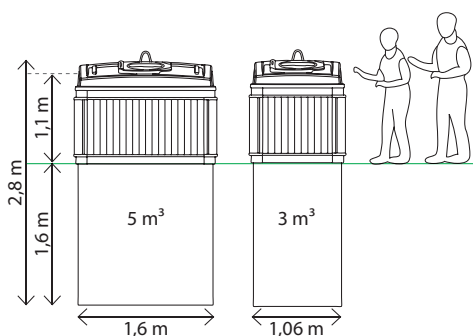

Kapasitet	Alternativ inndeling	Innkaståpning maks.	Alternativer for Løfteutstyr	Tilleggsinformasjon
5 m ³	1/1	500 x 500 mm	Løftesekk Forsterket løftesekk for glass/metall	Ytterbeholder i fiberarmert betong
2,4 m ³ 3,2 m ³ 1,6 m ³	1/2 2/3 1/3	430 x 370 mm 500 x 500 mm 290 x 390 mm	Løftecontainere for oppsamling av f.eks. matavfall eller vått avfall	
3 m ³	1/1 1/2	500 x 500 mm 290 x 390 mm		

Molok® Domino Plus

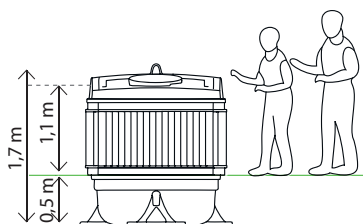

3 m ³	1/1	500 x 500 mm	Løftesekk Forsterket løftesekk for glass/metall	Ytterbeholder i HDPE
1,5 m ³ 2,2 m ³ 0,5 m ³	1/2 2/3 1/3	430 x 370 mm 500 x 500 mm 290 x 390 mm	Løfte containere	1/3 alltid med løftecontainere

Molok® Domino Light

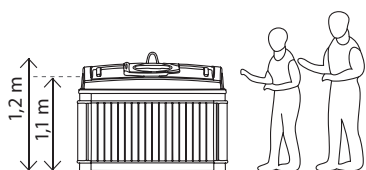

2 m ³	1/1	500 x 500 mm	Løftesekk Forsterket løftesekk for glass/metall	Ytterbeholder i HDPE
1 m ³ 1,5 m ³ 0,5 m ³	1/2 2/3 1/3	430 x 370 mm 500 x 500 mm 290 x 390 mm	Løfte containere	1/3 alltid med løftecontainere

Merk: Kroppsmål uten innramming.
Dimensjoner er veiledende.

Lokkalternativer



Standard lokk



Vertikalt lokk



Trommelokk



Brannhemmende lokk

Hovedlokket er svart. Fargealternativene på fyllingslokkene finner du nedenfor i brosjyren.
Tilbehør for å fylle lokk: Låse- og holdemagnet (anbefales ved vindforhold)

Trommelokk

Trommealternativer



35 liter HDPE
60 liter HDPE (standard)
80 liter Aluminium

Service Luke



Service Luke er standard
• på baksiden av lokket
• for visuell inspeksjon
• utstyrt med trekantlås

Påfyllingslokk



Det brukervennlige innkastlokket har en magnetisk lås som holder lokket åpent når du kaster avfallet.

Alternativer for løftesekk og løftebeholder

Forsterkede løftesekker for glass/metall for de vanligste beholderstørrelsene.

Løftesekker

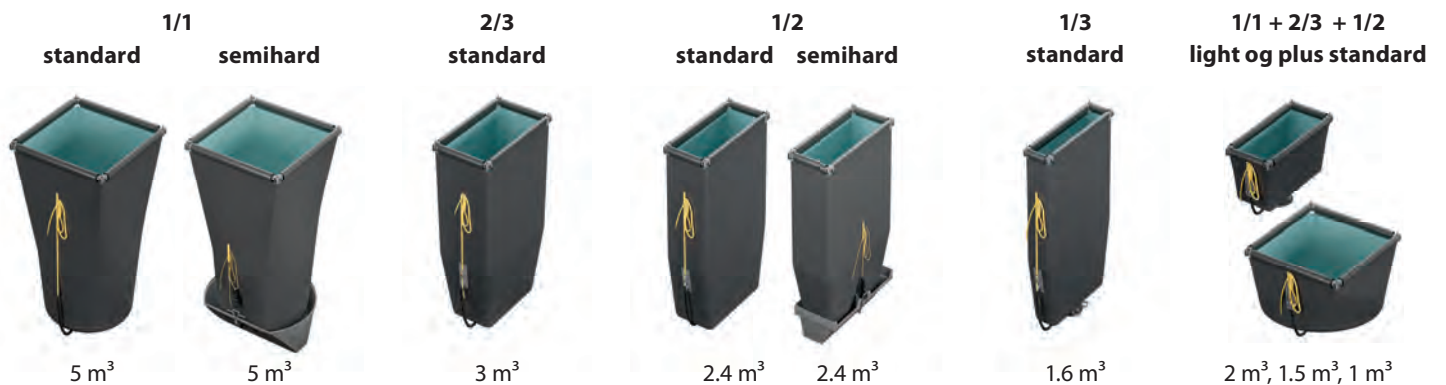

Løftebeholdere

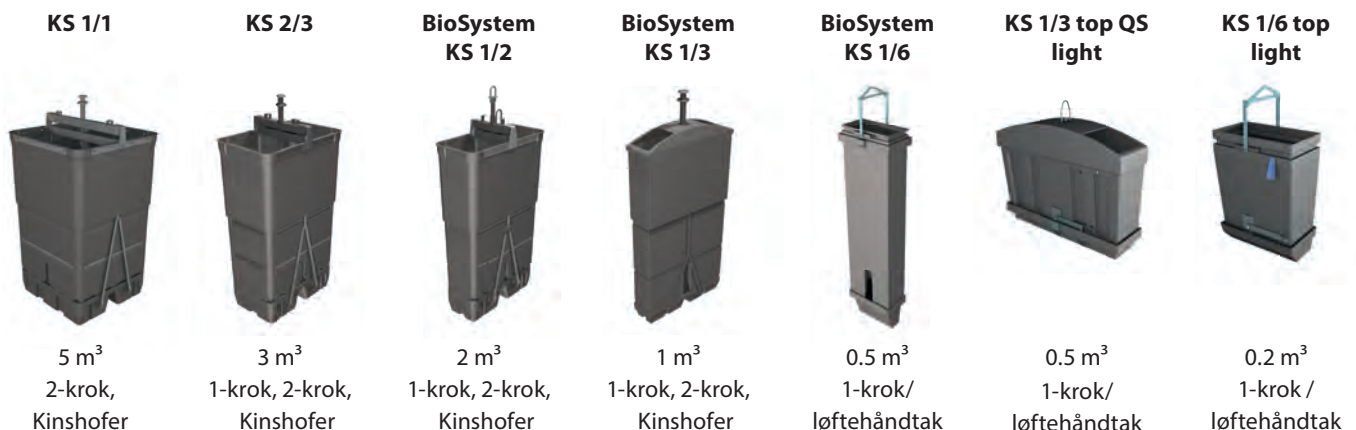

Molok[®]Classic Tilbehør

Molok[®]Classic 5 m³

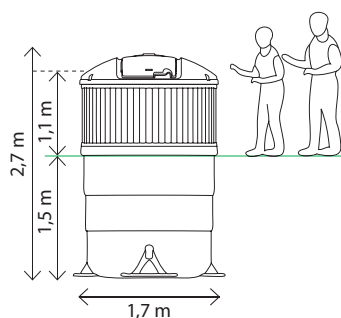

Molok[®]Classic 3 m³

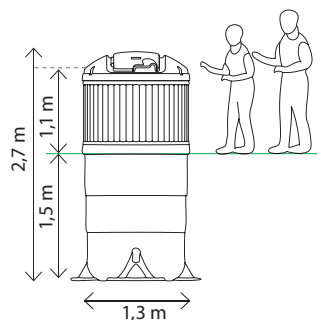

Molok[®]Classic 1,3 m³

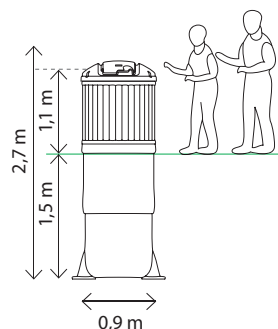

Kapasitet	Alternativ inndeling	Dimensjoner på åpningen	Alternativer for Løfteutstyr	Tilleggsinformasjon
5 m ³ 2,4 m ³	1/1 1/2	Innkaståpning størrelse min. 100 x 350 mm, maks. Ø 600 mm	Løftesekk Forsterket løftesekk for glass/metall Løftecontainer KSS5	Restavfall, papir, papp og tekstiler + plastemballasje
3 m ³		Innkaståpning størrelse min. 100 x 350 mm, maks. Ø 450 mm	Løftesekk Forsterket løftesekk for glass/metall Løftecontainer KSS3	Restavfall, papir, papp, metall, glass, tekstiler og plastemballasje
1,3 m ³		Innkaståpning størrelse min. 60 x 265 mm, maks. Ø 300 mm	Løftesekk Forsterket løftesekk for glass/metall BioSystem KS 800/1300 for innsamling av matavfall	Søppel (i parker), restavfall, plast, papp/papir, glass/metall og matavfall

Dimensjoner er veiledende.

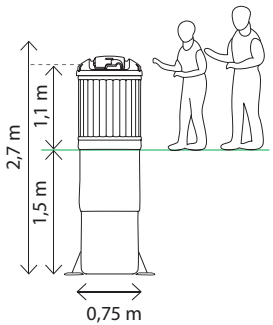
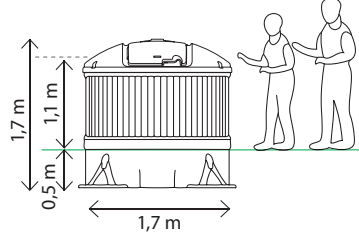
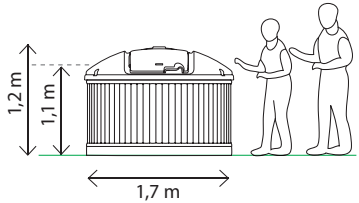
	Kapasitet	Alternativ inndeling	Dimensjoner på åpningen	Alternativer for Løfteutstyr	Tilleggsinformasjon
<p>Molok® Classic 800 l</p> 	800 l		Innkaståpning størrelse min. Ø 170 mm, maks. Ø 250 mm	Løftesekk Forsterket løftesekk for glass/metall BioSystem KS 500/800 for innsamling av matavfall	Søppel (i parker), restavfall, plast, papp/papir, matavfall og glass/metall
<p>Molok® Classic Plus</p> 	3 m ³		Innkaståpning størrelse min. 100 x 350 mm, maks. Ø 600 mm	Løftesekk Forsterket løftesekk for glass/metall	Restavfall, plast, papp/papir, matavfall og glass/metall
<p>Molok® Classic Light</p> 	2 m ³ 1 m ³	1/1 1/2	Innkaståpning størrelse min. 100 x 350 mm, maks. Ø 600 mm	Løftesekk Forsterket løftesekk for glass/metall	Restavfall, plast, papp/papir, matavfall og glass/metall

Dimensjoner er veiledende.

Lokkalternativer



Standard lokk



Åpent vertikalt lokk
(5 m³ og 1,3 m³)



Vertikalt lokk med
innkastlokk
(5 m³ og 1,3 m³)



Vertikalt lokk med to
påfyllingslokk (5 m³)



Trommelokk
(5 m³ og 3 m³)

Hovedlokket er svart. Fargealternativene på innkastlokkene finner du nedenfor i brosjyren.
Tilbehør for innkastlokk: Låse- og holdemagnet (anbefales ved vindforhold)

Alternativer for innsamlingsutstyr

Forsterkede løftesekker for glass/metall for de vanligste beholderstørrelsene.

Standard
5 m³ og 3 m³



Standard
1,3 m³



Standard
0,8 m³



Light Standard
2 m³



Plus Standard
3 m³



Semihard
5 m³ og 3 m³



BioSystem
KS800/1300



BioSystem
KS500/800



KSS5
løfte container



KSS3
løfte container



BioSystem løftecontainere:

- for matavfall, glass/metall
- 800 l løftebeholder for 1,3 m³ beholder
- 500 l løftebeholder for 800 l beholder
- BioSystem 800/1300 også tilgjengelig som 2-kroker versjon

KSS løftecontainere:

- 4 200 l løftebeholder for 5 m³ beholder
- 2 500 l løftebeholder for 3 m³ beholder

Løftemuligheter for KSS liftin containere:

- 1-krok som standard
- Også tilgjengelig i Kinshofer, 2-krok- og løfteløkkemodeller

Paneler og kledning

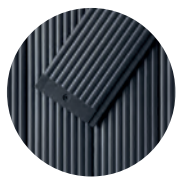

EcoFrame
Resirkulert plast
4 farger



AluFrame
Aluminium
Natur- og RAL-farger



PrintFrame
Trykk i
vannbestandig
materiale –
kundetilpasses



CustomFrame
Materiale som
kundetilpasses

EcoFrame farger



Midnattssvart



Grafittgrå



Kaffebrun



Murstein brun

Farger innkastlokk



Sort (standard)



Mørkegrå

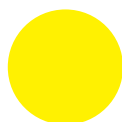

Gul

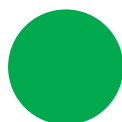

Grønn



Blå



Brun



Rød



Hvit



Oransje

Fargene er veiledende.

Avfallssymboler for skilt

Avfallsfraksjonssymboler gjør det enklere å sortere og resirkulere avfall: hver avfallsfraksjon har sitt eget symbol. Symbolene oppfordrer folk til å resirkulere. Når beholderen er tydelig merket, er det enkelt å sortere avfallet.

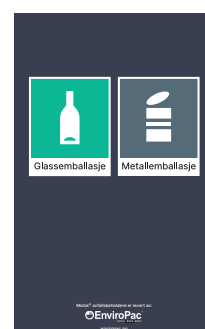
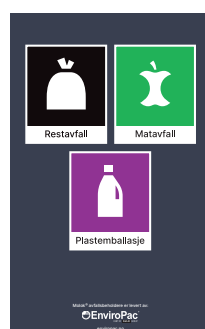
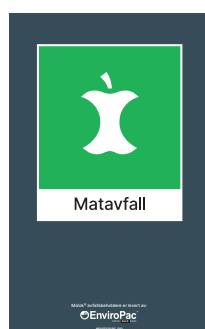
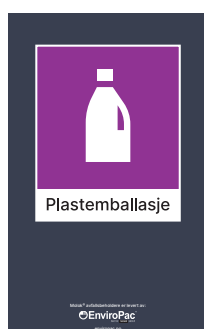
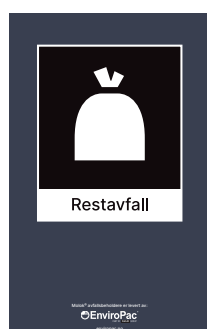

Molok®
over hele verden

Flere enn
200 000 beholdere
I mer enn 45 land

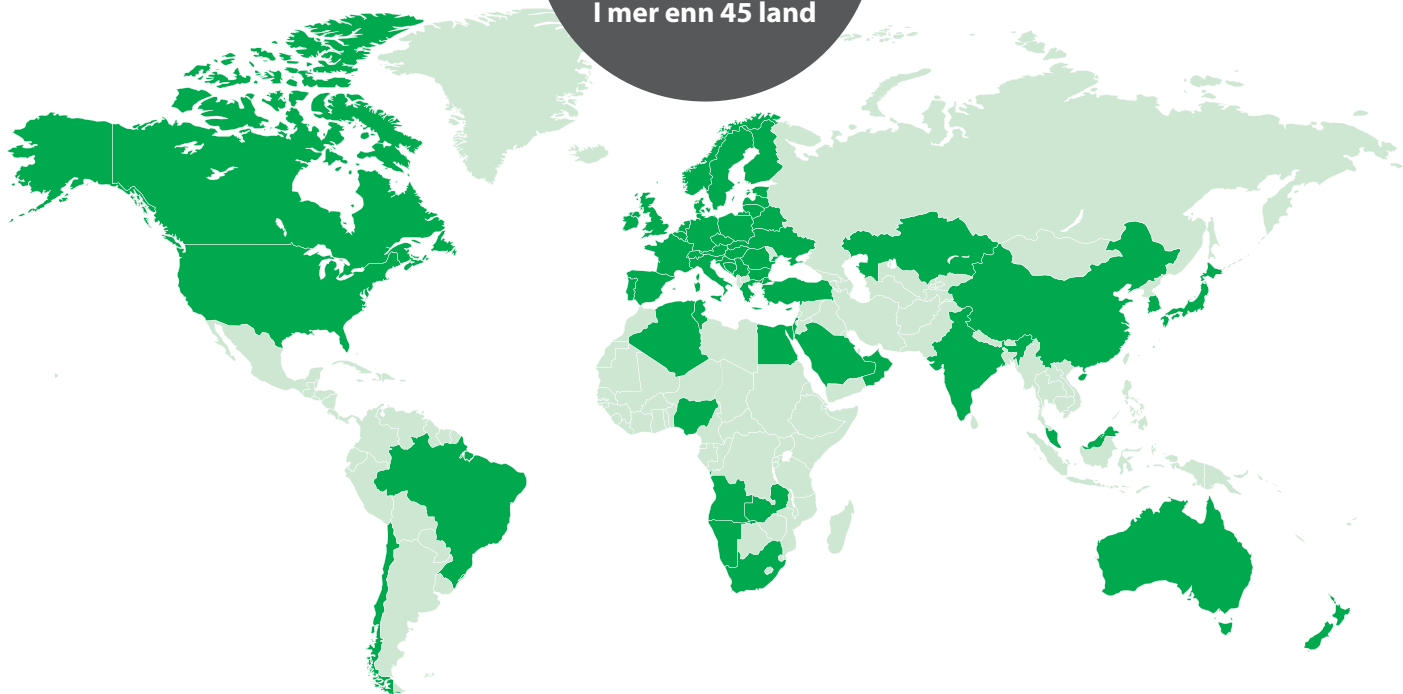

EnviroPac er sammen med Molok en del av SULO Group, som er Europas ledende leverandører av maskiner, containere og utstyr til kildesortering og oppbevaring av avfall. I Norge har vi i tillegg til EnviroPac selskapene Euroteknikk AS og EnviroPac Utleie AS.

Vi sikrer din bedrift miljøvennlige og rasjonelle løsninger. En tydelig miljøprofil sammen med lønnsomhet er avgjørende for å kunne ta kloke valg og møte fremtidens utfordring innenfor sirkulærøkonomien.

Vår erfaring og kunnskap gir kildesortering med en rød tråd gjennom hele ditt prosjekt.

Salg & service i hele landet.

Ta kontakt med oss for en uforpliktende konsultasjon eller befaring: info@enviropac.no - tel. 400 06 130



EnviroPac®

PART OF **SULO** GROUP